

UMPISOLMU

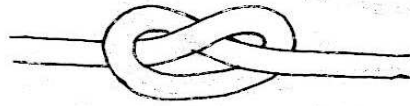

MERIMIESSOLMU (= REIVISOLMU)

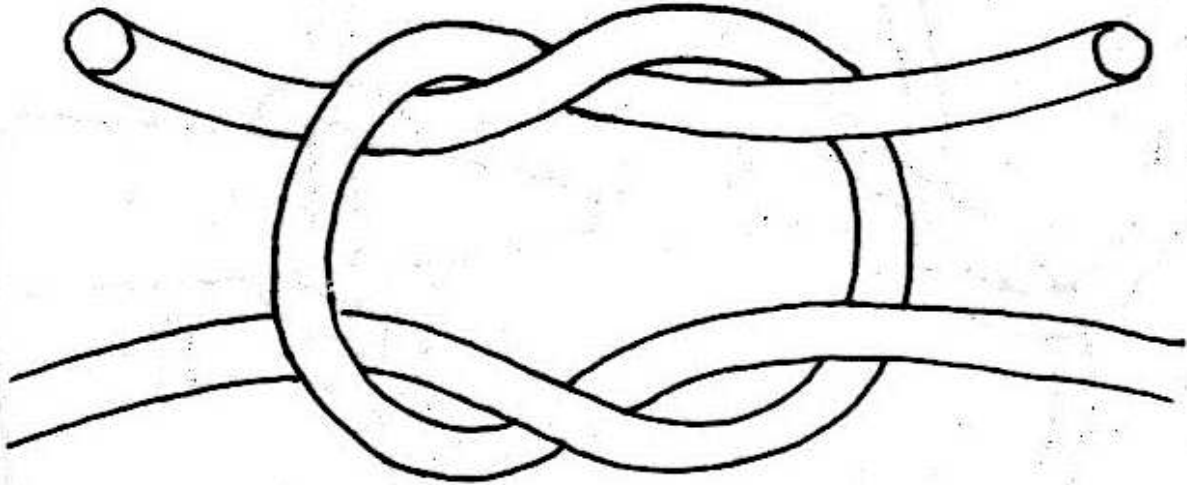

Huomaa, että lyhyet päät ovat samalla puolella! Alla ensin **VARKAANSOLMU**:

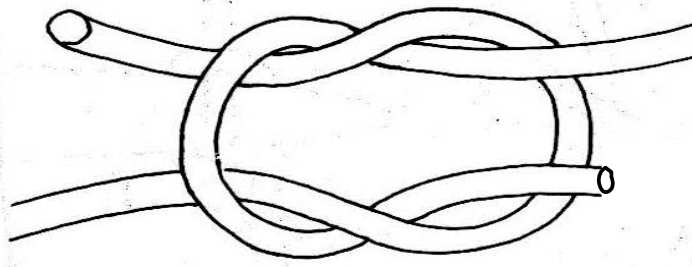

ÄMMÄNSOLMU (lyhyet sama puoli)

MURHESOLMU (lyhyet eri puoli)

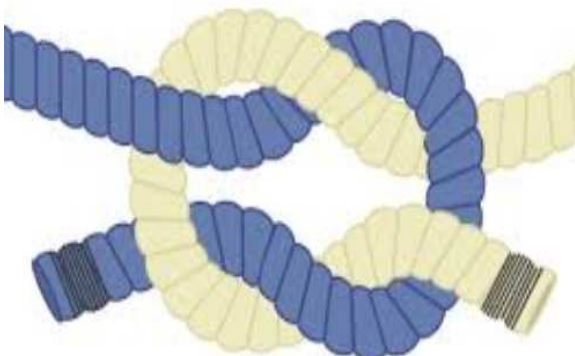

JALUSSOLMU

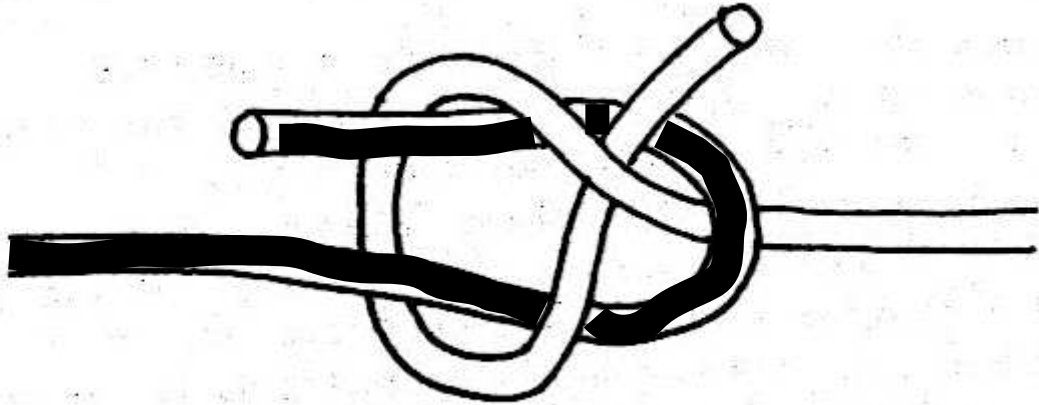

KERROTTU JALUSSOLMU = LIPPUSOLMU

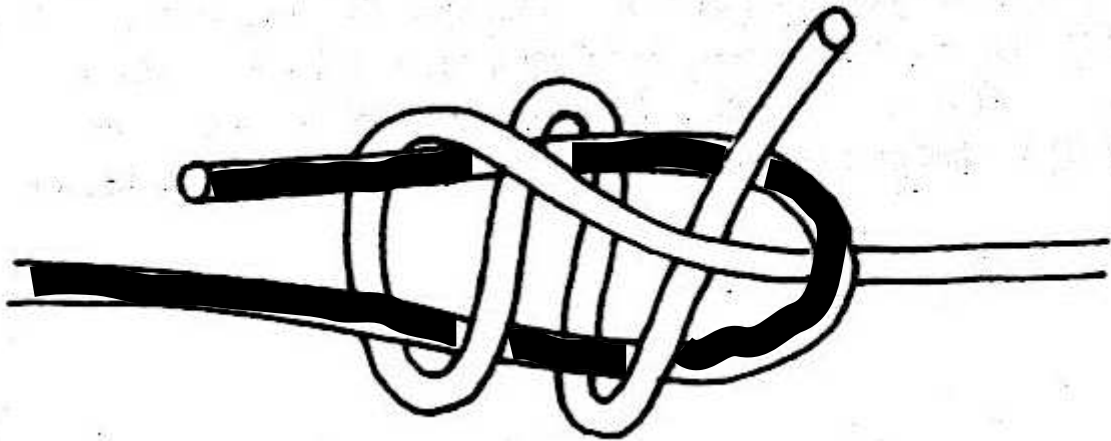

Esim. lipun metallilenkki paksu musta

KAHDEKSIKKO-SOLMU

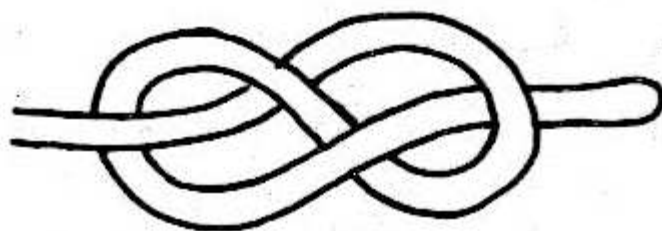

SIANSORKKA-SOLMU

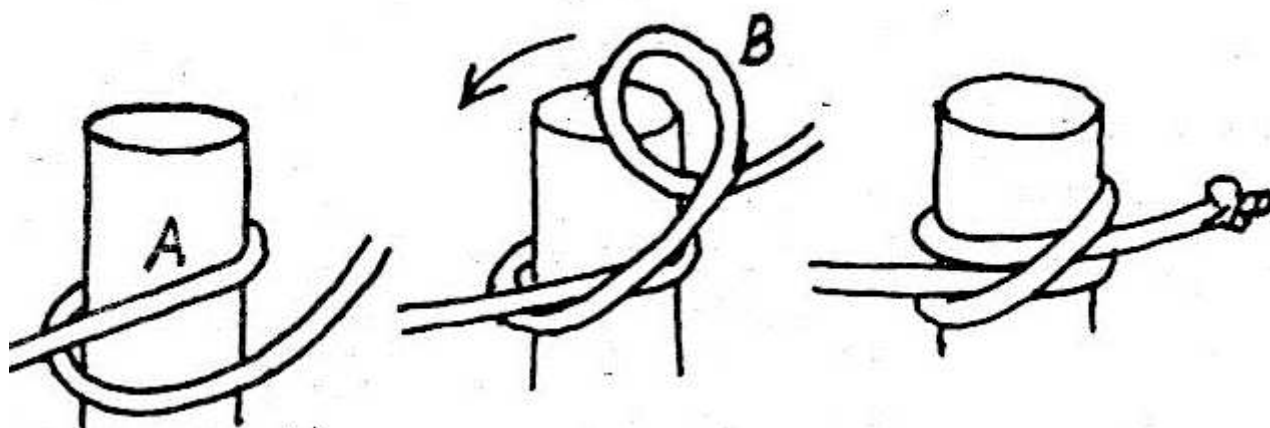
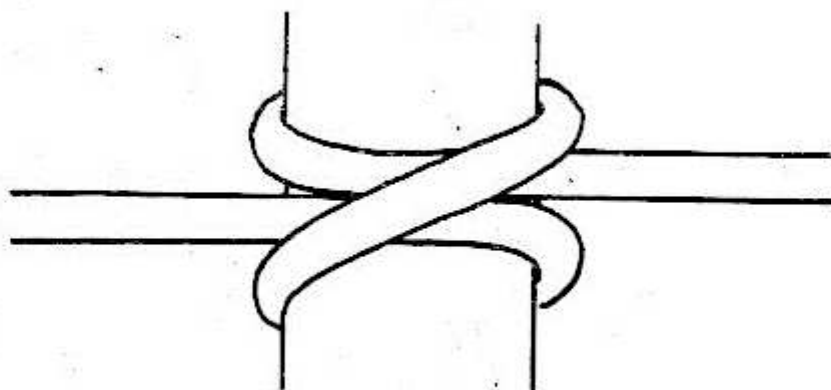

PAALUSOLMU

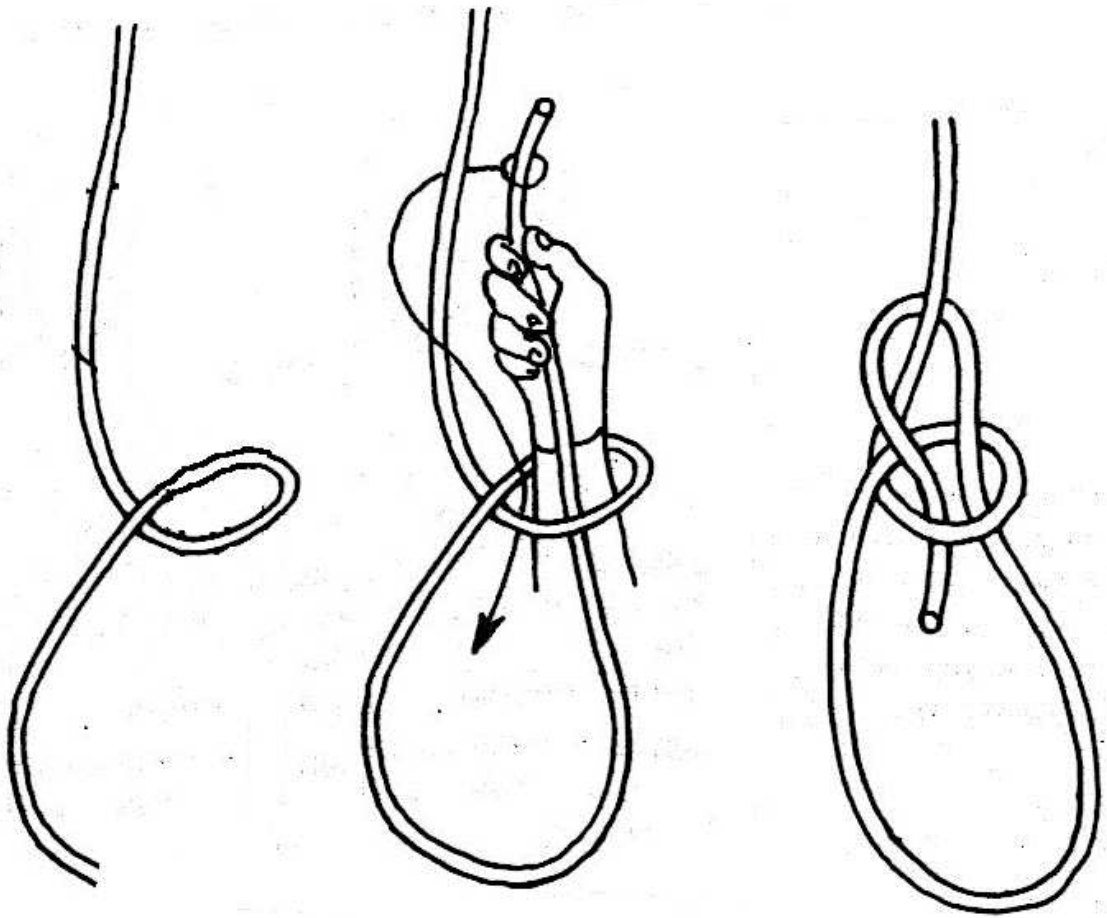

TUKKIKYTKY

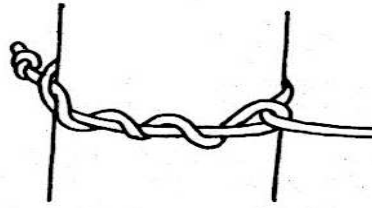

PUKKIKÖYTÖS (aloita tukkikytkyllä)

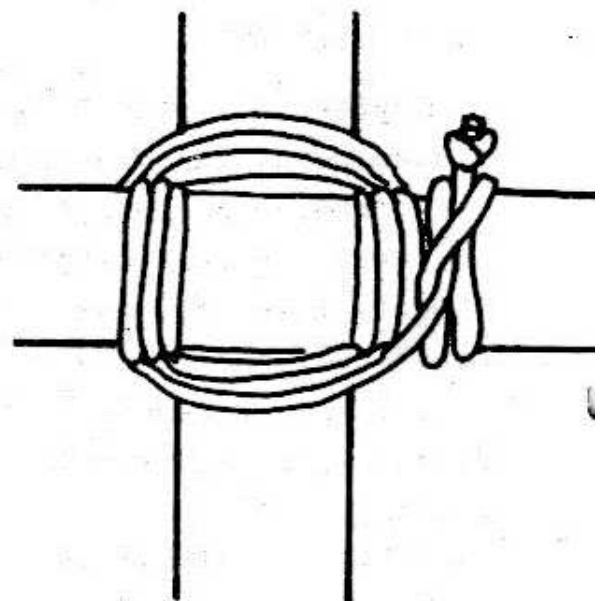
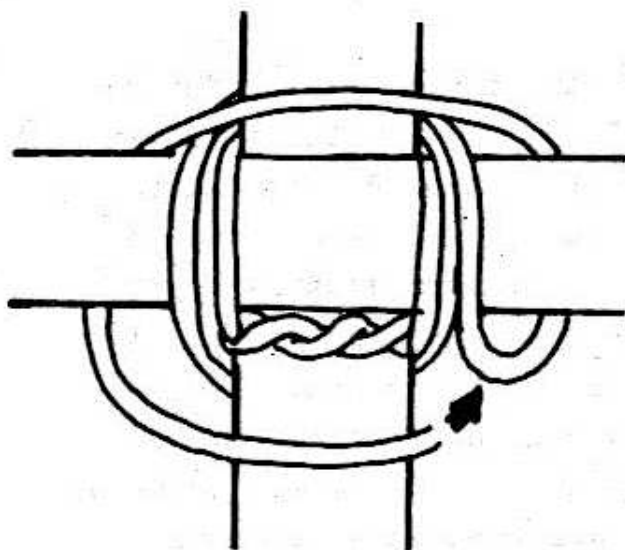
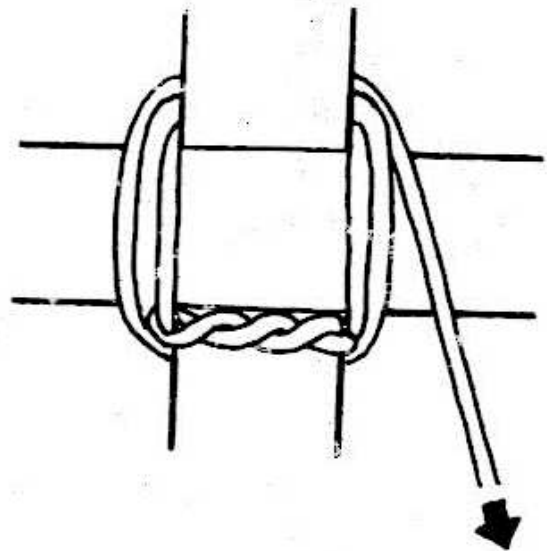
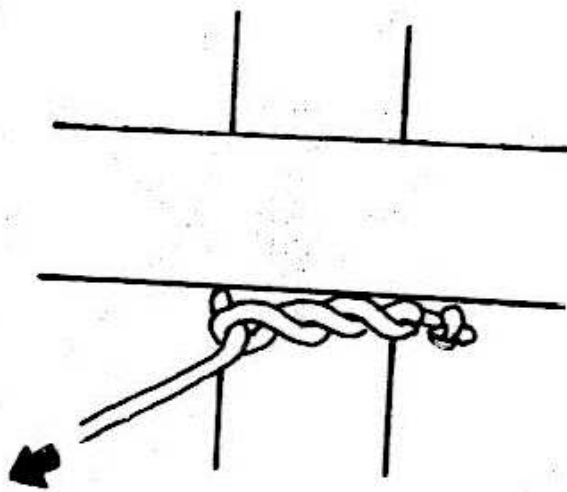

RISTIKÖYTÖS

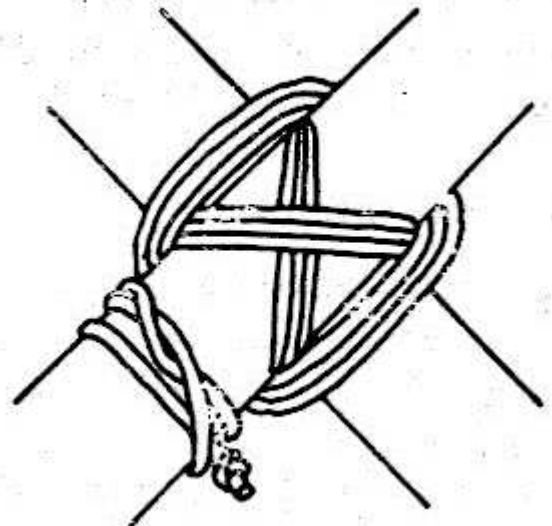
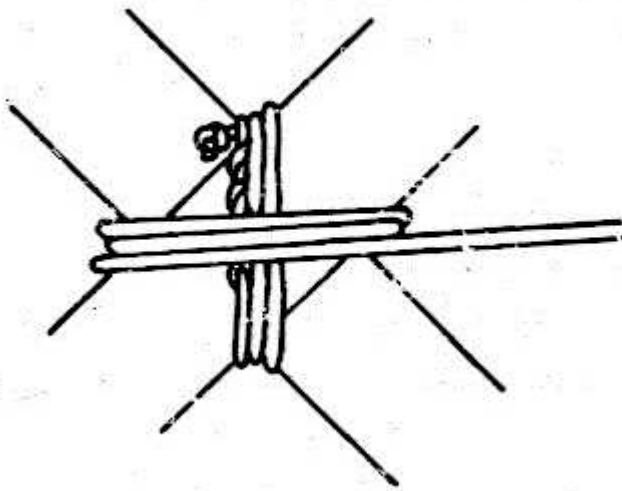
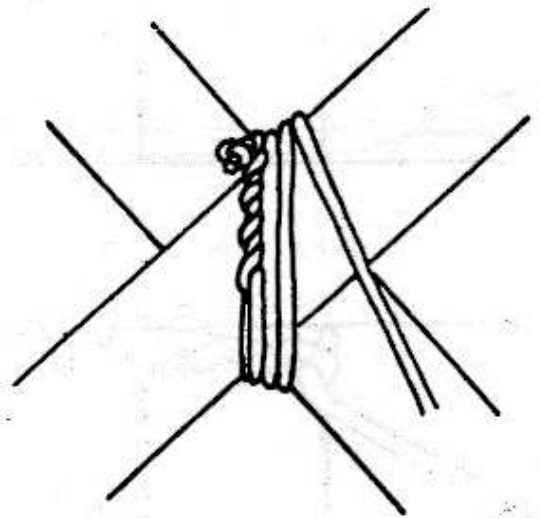
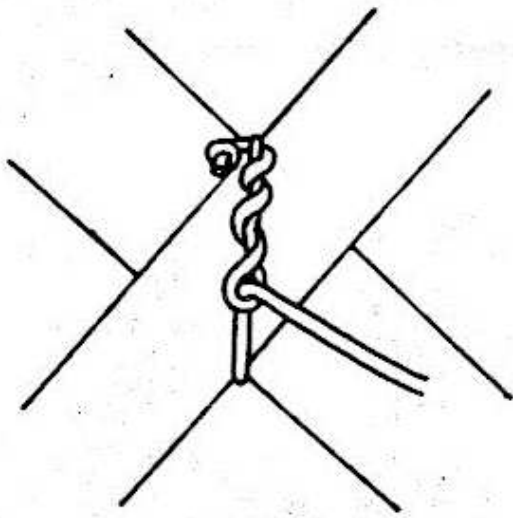

YHDYSKÖYTÖS

